

Procedure for greasing and adjusting bearings

The number one cause of axle vibration and/or failure is insufficiently greased or improperly tightened wheel bearings. This problem can easily be avoided by simply following the procedures on this page. It is important that this is done after the first 50 miles and every 2000 miles or annually, whichever comes first.

Your axle is equipped with the **Dexter E-Z Lube** feature. The bearings can be periodically lubricated without removing the hubs from the axle. This feature consists of axle spindles that have been specially drilled and fitted with a grease zerk in their ends. When grease is pumped into the zerk, it is channeled to the inner bearing and then flows back to the outer bearing and eventually back out the grease cap hole. The E-Z Lube feature is designed to allow immersion, without the need for repacking bearings.

The procedure is as follows:

1. Remove the rubber plug from the end of the grease cap.
2. Place a standard grease gun onto the grease zerk located in the end of the spindle. Make sure the grease gun nozzle is fully engaged on the fitting.
3. Pump grease into the zerk. The old, displaced grease will begin to flow back out the cap around the grease gun nozzle.
4. When the new, clean grease is observed, remove the grease gun, wipe off any excess, and replace the rubber plug in the cap.

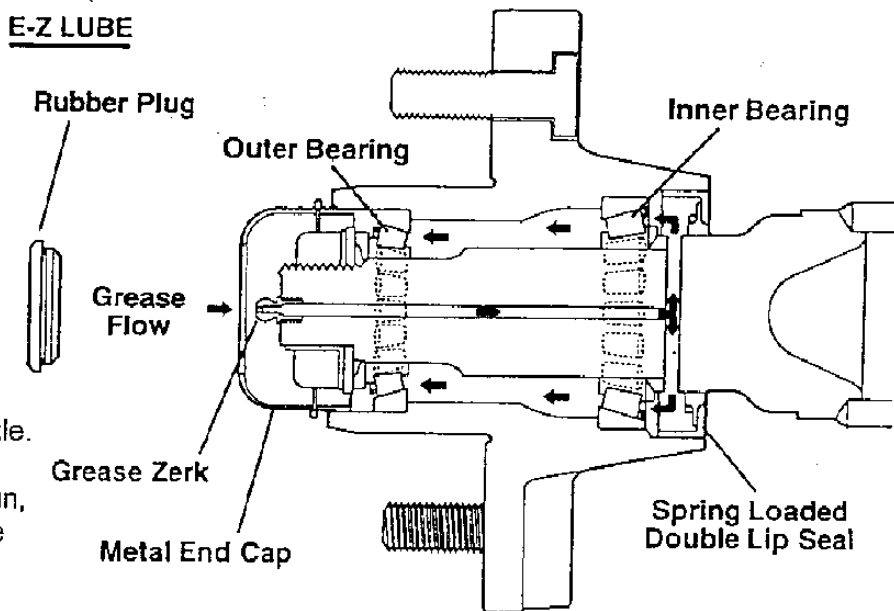

Note: If hubs are removed from an axle with the E-Z Lube feature, it is imperative that the seals be replaced **before** bearing lubrication. Otherwise, the chance of grease getting on brake linings is greatly increased.

Seal Inspection and Replacement

Whenever the hub is removed, inspect the seal to assure that it is not nicked or torn and is still capable of properly sealing the bearing cavity. If there is any question of condition, replace the seal. To replace the seal:

1. Pry the seal out of the hub with a screwdriver. Never drive the seal out with the inner bearing as you may damage the bearing.
2. Apply a Permatex sealant to the outside of the new seal.
3. Tap the new seal into place using a clean wood block.

Bearing Adjustment and Hub Replacement

If the hub has been removed or bearing adjustment is required, the following adjustment procedure must be followed:

1. After placing the hub, bearings, washers, and spindle nut back on the axle spindle, rotate the hub assembly slowly while tightening the spindle nut to approximately 50 lbs.-ft (12" wrench or pliers with full hand force.)
2. Then loosen the spindle nut to remove the torque. **Do not rotate the hub.**
3. Finger tighten the spindle nut until just snug.
4. Back the spindle nut out slightly until the first castellation lines up with the locking tang.
5. Bend over the locking tang. Nut should be free to move with only restraint being the locking tang.



4. Continue this process until you have the entire bearing completely filled with grease.
5. Before reinstalling, apply a light coat of grease on the bearing cup.

Bearing Lubrication - Oil

If your axles are equipped with oil lubricated hubs, periodically check and refill the hub as necessary with a high quality hypoid gear oil to the level indicated on the clear plastic oil cap. The oil can be filled from either the oil fill hole, if present, in the hub or through the rubber plug hole in the cap itself.

Recommended Wheel Bearing Lubrication Specifications

Grease:

Thickener Type	Lithium Complex
Dropping Point	215°C (419°F) Minimum
Consistency	NLGI No. 2
Additives	EP, Corrosion & Oxidation Inhibitors
Viscosity Index	80 Minimum

Approved Sources:

Mobil Oil	Mobilgrease HP, Mobilith AW2
Exxon/Standard	Ronex MP
Kendall Refining Co.	Kendall L-427
Ashland Oil Co.	Valvoline Multipurpose GM
76 Lubricants	76 Multiplex EP
Citgo Petroleum	Lithoplex MP#2
Mystik	Mystik JT-6 Hi Temp Grease

Oil:

SAE 90, SAE 80W-90, SAE 75W-90

Approved Sources:

Union Oil Co.	Unocal MP Gear Lube
Exxon Co. USA	Gear Oil GX 80W-90
Mobil Oil Corp	Mobilube SHC 75W-90
Pennzoil Prod. Co.	Gear Plus 80W-90 GL-5
	Gear Plus Super 75W-90

Note: The convenient lubrication provisions of the E-Z Lube™ and the oil lubrication must not replace periodic inspection of the bearings.

Seal Inspection and Replacement

Whenever the hub is removed, inspect the seal to assure that it is not nicked or torn and is still capable of properly sealing the bearing cavity. If there is any question of condition, replace the seal. Use only the seals specified in the Seal Replacement Chart. To replace the seal:

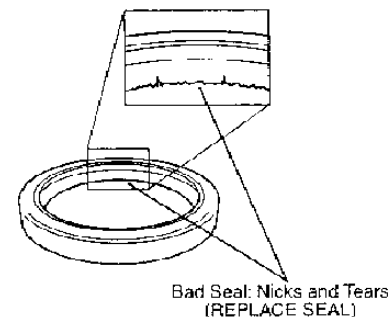

1. Pry the seal out of the hub with a screwdriver. Never drive the seal out with the inner bearing as you may damage the bearing.

2. Apply a PERMATEX sealant to the outside of the new seal.

Note: Permatex sealant should not be used on rubber encased seals.

3. Tap the new seal into place using a clean wood block.

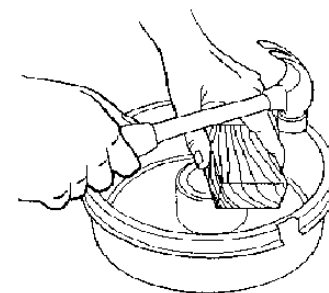

Bearing Adjustment and Hub Replacement

If the hub has been removed or bearing adjustment is required, the following adjustment procedure must be followed:

1. After placing the hub, bearings, washers, and spindle nut back on the axle spindle in reverse order as detailed in the previous section on hub removal, rotate the hub assembly slowly while tightening the spindle nut to approximately 50 lbs.-ft. (12" wrench or pliers with full hand force.)
2. Then loosen the spindle nut to remove the torque. Do not rotate the hub.
3. Finger tighten the spindle nut until just snug.
4. Back the spindle nut out slightly until the first castellation lines up with the cotter key hole and insert the cotter pin (or locking tang in the case of E-Z Lube™).



Hubs/Drums/Bearings

Dexter Axle offers several types of bearing arrangements and lubrications methods.

- Dexter's standard wheel bearing configuration consists of opposed tapered roller bearing cones and cups, fitted inside of a precision machined cast hub. This method of using tapered roller bearings requires that a minimal amount of axial end play be provided at assembly. This end play is essential to the longevity of the bearings service life. This design is typically lubricated with grease, packed into the bearings. Oil lubrication is another method which is available in some of the larger axle capacities.

- E-Z Lube™ is another option chosen by some trailer manufacturers. If your axle is equipped with the Dexter E-Z Lube™ feature, the bearings can be periodically lubricated without removing the hubs from the axle. This feature consists of axle spindles that have been specially drilled and assembled with grease fittings in their ends. When grease is pumped into the fitting, it is channeled to the inner bearing and then flows back to the outer bearing and eventually back out the grease cap hole.

- Nev-R-Lube™ option is the latest innovation from Dexter. Nev-R-Lube™ bearings are comprised of opposed tapered roller bearing cones sealed inside of a precision ground, one piece double cup arrangement. These bearings are designed with a small amount of axial end play. This end play is essential to the longevity of the bearings service life. They are lubricated, assembled and sealed at the factory. No further lubrication is ever needed.

Before attempting any disassembly of your Dexter axle, make sure you read and follow the instructions for the appropriate axle type.

Hub Removal - Standard Bearings

Whenever the hub equipment on your axle must be removed for inspection or maintenance the following procedure should be utilized.

1. Elevate and support the trailer unit per manufacturers' instructions.



CAUTION:

Failure to do proper and periodic maintenance of these important structural parts may result in severe and catastrophic injury or damage to property.

2. Remove the wheel.
3. Remove the grease cap by carefully prying progressively around the flange of the cap. If the hub is an oil lube type, then the cap can be removed by unscrewing it counterclockwise while holding the hub stationary.
4. Remove the cotter pin from the spindle nut or, in the case of E-Z Lube™ versions, bend the locking tang to the free position.
For E-Z Lube™ axles produced after February 2002, a new type of retainer is used. Gently pry off retainer from the nut and set aside.
5. Unscrew the spindle nut (counterclockwise) and remove the spindle washer.
6. Remove the hub from the spindle, being careful not to allow the outer bearing cone to fall out. The inner bearing cone will be retained by the seal.
7. For 7,200 lb. and 8,000 lb. axles, a hub puller should be used to assist in drum removal.

Brake Drum Inspection

There are two areas of the brake drum that are subject to wear and require periodic inspection. These two areas are the drum surface where the brake shoes make contact during stopping and the armature surface where the magnet contacts (only in electric brakes).

The drum surface should be inspected for excessive wear or heavy scoring. If worn more than .020" oversized, or the drum has worn out of round by more than .015", then the drum surface should be re-machined. If scoring or other wear is greater than .090" on the diameter, the drum must be replaced. When turning the drum surface, the maximum rebore diameter is as follows:

- 7" Brake Drum-7.090" diameter
- 10" Brake Drum-10.090" diameter
- 12" Brake Drum-12.090" diameter
- 12¹/₄" Brake Drum-12.340" diameter

The machined inner surface of the brake drum that contacts the brake magnet is called the armature surface. If the armature surface is scored or worn unevenly, it should be refaced to a 120 micro inch finish by removing not more than .030" of material. To insure proper contact between the armature face and the magnet face, the magnets should be replaced whenever the armature surface is refaced and the armature surface should be refaced whenever the magnets are replaced.

Note: It is important to protect the wheel bearing bores from metallic chips and contamination which result from drum turning or armature refacing operations. Make certain that the wheel bearing cavities are clean and free of contamination before reinstalling bearing and seals. The presence of these contaminants will cause premature wheel bearing failure.

Bearing Inspection

Wash all grease and oil from the bearing cone using a suitable solvent. Dry the bearing with a clean, lint-free cloth and inspect each roller completely.



CAUTION:

*Never spin the bearing with compressed air.
THIS CAN DAMAGE THE BEARING.*

If any pitting, spalling, or corrosion is present, then the bearing must be replaced. The bearing cup inside the hub must be inspected.

IMPORTANT: Bearings must always be replaced in sets of a cone and a cup.



CAUTION:

Be sure to wear safety glasses when removing or installing force fitted parts. Failure to comply may result in serious eye injury.

When replacing the bearing cup proceed as follows:

1. Place the hub on a flat work surface with the cup to be replaced on the bottom side.
2. Using a brass drift punch, carefully tap around the small diameter end of the cup to drive out.
3. After cleaning the hub bore area, replace the cup by tapping in with the brass drift punch. *Be sure the cup is seated all the way up against the retaining shoulder in the hub.*

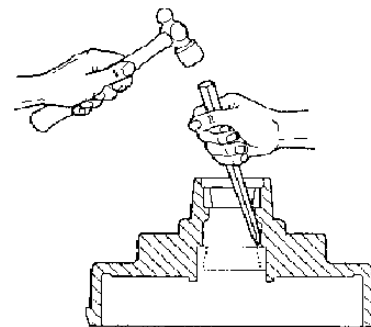

Bearing Lubrication - Grease

Along with bearing adjustment, proper lubrication is essential to the proper function and reliability of your trailer axle. Bearings should be lubricated every 12 months or 12,000 miles. The method to repack bearing cones is as follows:

1. Place a quantity of grease into the palm of your hand.
2. Press a section of the widest end of the bearing into the outer edge of the grease pile closest to the thumb forcing grease into the interior of the bearing.
3. Repeat this while rotating the bearing from roller to roller.

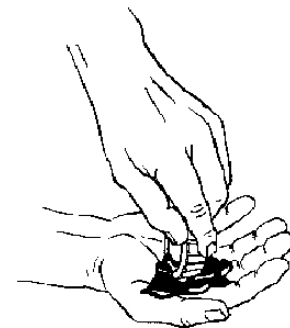

5. Bend over the cotter pin legs to secure the nut (or locking tang in the case of E-Z Lube™).
6. Nut should be free to move with only restraint being the cotter pin (or locking tang).

For axles using the new nut retainer:

1. Finger tighten the nut until just snug, align the retainer to the machined flat on the spindle and press the retainer onto the nut. The retainer should snap into place. Once in place, the retainer/nut assembly should be free to move slightly.
2. If the nut is too tight, remove the retainer and back the nut off approximately one twelfth of a turn and reinstall the retainer. The nut should now be free to move slightly.
3. Reinstall grease cap.

Typical E-Z Lube™ Prior to Spring 2002

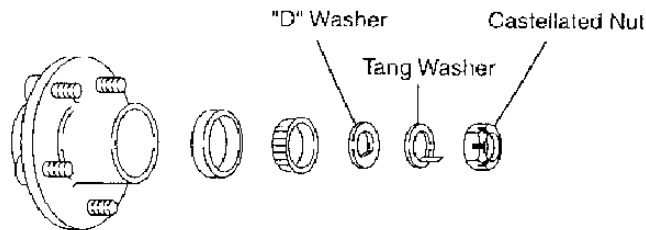

Typical E-Z Lube™ After Spring 2002

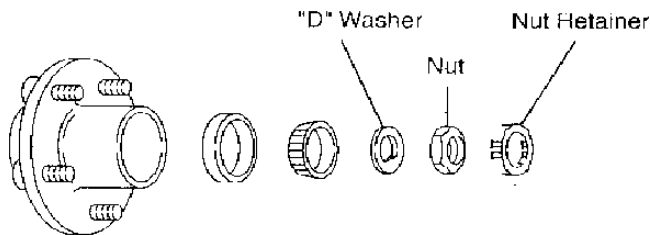

E-Z Lube™ Lubrication

The procedure is as follows:

1. Remove the rubber plug from the end of the grease cap.
2. Place a standard grease gun onto the grease fitting located in the end of the spindle. Make sure the grease gun nozzle is fully engaged on the fitting.
3. Pump grease into the fitting. The old displaced grease will begin to flow back out the cap around the grease gun nozzle.
4. When the new clean grease is observed, remove the grease gun, wipe off any excess, and replace the rubber plug in the cap.
5. Rotate hub or drum while adding grease.

Note: The E-Z Lube™ feature is designed to allow immersion in water. Axles not equipped with E-Z Lube™ are not designed for immersion and bearings should be repacked after each immersion. If hubs are removed from an axle with the E-Z Lube™ feature, it is imperative that the seals be replaced BEFORE bearing lubrication. Otherwise, the chance of grease getting on brake linings is greatly increased.

